

INSTRUCTIONS
for
VELOCITY MICROPHONE
TYPE 44-A
with
ACCESSORIES



R C A Victor Company, Inc.
Camden, N. J., U. S. A.

TABLE OF CONTENTS

PART I—DESCRIPTION

<i>Section</i>	<i>Title</i>	<i>Page</i>
1	Introduction.....	5
2	Description.....	5
3	Sensitivity.....	5
4	Quality of Response.....	6
5	Directional Characteristics.....	6

PART II—OPERATION

6	Microphone Assembly.....	7
	(a) <i>Stand Mounting</i>	7
	(b) <i>Suspension Mounting</i>	7
	(c) <i>Assembly of Wind Screen</i>	7
	(d) <i>Cable Connections</i>	8
7	Technique of Velocity Microphone Placement.....	9
	(a) <i>General</i>	9
	(b) <i>Soloist with Piano</i>	9
	(c) <i>Plays</i>	10
	(d) <i>Dance Orchestra</i>	10
	(e) <i>Large Orchestra</i>	10
	(f) <i>Special Considerations for Sound Motion Picture Recording</i>	10
	(g) <i>Public Address</i>	12
	(h) <i>Sound Reinforcing</i>	12
8	Operation.....	12
9	List of Parts and Accessories.....	13

LIST OF ILLUSTRATIONS

<i>Figure</i>	<i>Title</i>	<i>Page</i>
1	Microphone on Program Stand.....	5
2	Close-up of Microphone on Program Stand.....	6
3	Microphone Suspended.....	6
4	Microphone with Wind Screen.....	7
5	Schematic Wiring.....	8
6	Plug and Receptacle Connections.....	8
7	Directional Characteristics.....	9
8	Microphone Arrangement—Soloist with Piano.....	10
9	Microphone Arrangement—Plays.....	10
10	Microphone Arrangement—Dance Orchestra.....	10
11	Microphone Arrangement—Large Orchestra.....	11
12	Microphone Arrangement—Camera Location.....	11
13	Plugs and Receptacles.....	12
14	Microphone on Announce Stand.....	13

OPERATING INSTRUCTIONS

FOR

VELOCITY MICROPHONE

TYPE 44-A

PART 1—DESCRIPTION

1. Introduction.—The velocity microphone is the result of several years of intensive research and development toward the improvement of the characteristics of microphones as used for broadcasting and recording purposes, and is entirely different in principle and construction from other microphones now in use. This microphone is admirably suited to studio pickup, public address and sound reinforcement applications.

Instead of a “diaphragm” (in the commonly accepted meaning of the word), the velocity microphone contains a thin metallic ribbon suspended between the poles of a permanent magnet with its length perpendicular to, and its width in the plane of, the magnetic lines of force. The opposite ends of the ribbon are connected to a transformer which matches the impedance of the ribbon to a 250 or 25 ohm line. Sound waves reaching the ribbon vibrate it within the magnetic field set up by the magnet. The vibration of the ribbon is in exact accordance with the sound vibrations and, occurring as it does within the magnetic field, sets up corresponding alternating electric potentials across the primary of its associated transformer. These minute voltages are subsequently amplified to the power level required for broadcasting. The microphone amplifier may be located remotely from the microphone unit when necessary or desirable.

2. Description.—The velocity microphone shown in Figure 1 consists of a microphone unit mounted on a swivel at the top of a program stand. The swivel mount permits the “aiming” of the transmitter in any desired direction. The transmitter is enclosed within a perforated metal casing which serves to protect it from mechanical injury and adverse wind effects.

The line coupling transformer is contained in a metal case as a part of the microphone unit.

The Type 44-A microphone unit is furnished with screw-mounting collar (program stand flange) to fit a standard Type AZ-4090 microphone stand. A suspension mounting (Type UP-4212) is also supplied with the microphone to permit the unit to be suspended overhead when desired. This location of the microphone is that generally used in sound motion picture recording. See Figure 3.

The microphone program stand (Type AZ-4090) is of the adjustable single vertical column type with

a three point base. The height of the transmitter may be adjusted to maximum and minimum heights of 81 inches and 56 inches respectively.

3. Sensitivity.—With an input sound pressure of 10 dynes per square centimeter perpendicular to the plane of the ribbon, the ribbon microphone unit will deliver 450 microvolts across a 250 ohm load, which is equivalent to an output level of

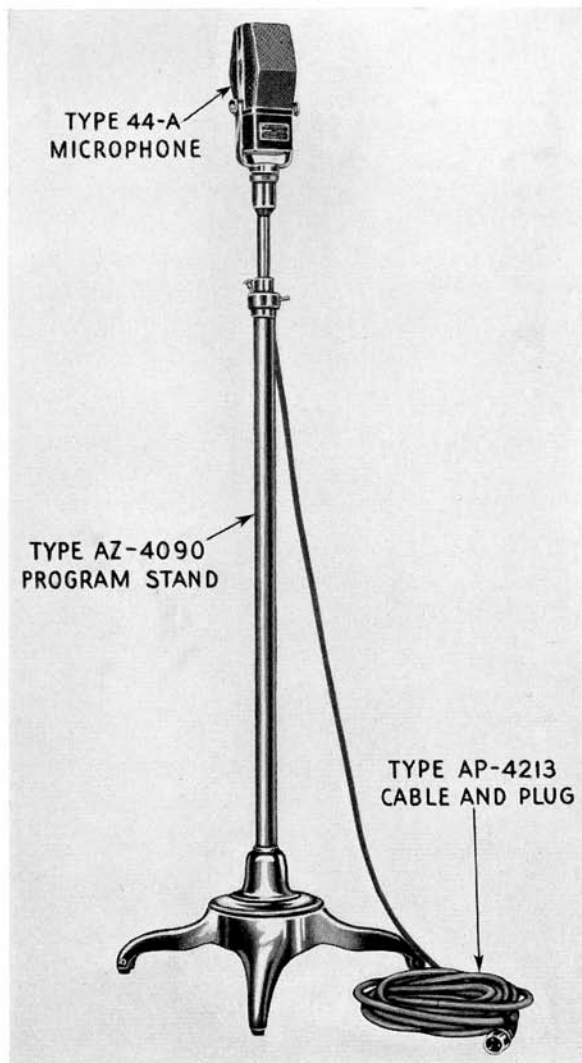

Figure 1—Microphone on Program Stand

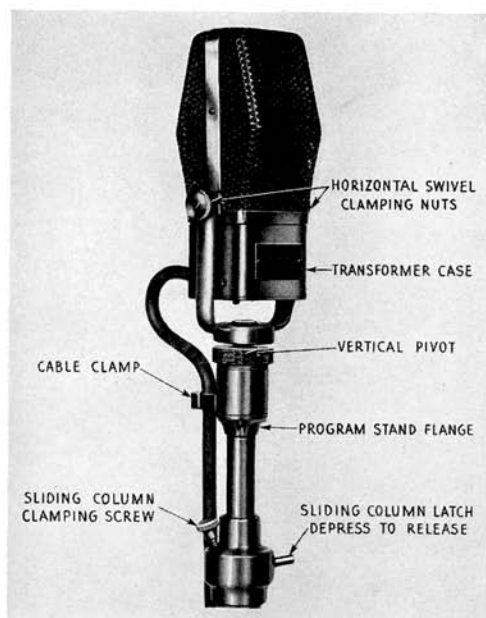

Figure 2—Close-up of Microphone on Program Stand

—72 db. as compared with a zero level of 12.5 milliwatts, or —69 db. as compared with a zero level of 6 milliwatts.

On an open circuit basis of measurement, *i. e.*, with an input of 1 dyne per square centimeter (1 bar) perpendicular to the ribbon, the output of the microphone across an open circuit is the equivalent of —86 db. with reference to a zero level of 12.5 milliwatts.

4. Quality of Response.—The operating range of the microphone extends from 70 cycles to 15,000 cycles. When the microphone is located less than 2 feet from the source of sound the low frequency response is increased somewhat, and when operated at a greater distance (up to 4 feet) the low frequency response is slightly attenuated. Beyond the 4-foot operating distance the response characteristic is unchanged by changes in the operating distance. The frequency response is essentially unchanged by the direction of the incident sound.

5. Directional Characteristics.—One of the most important characteristics of the velocity microphone is its directional property. Since the ribbon is suspended in free space, sound waves approaching the microphone from a direction in the same plane as the ribbon have no effect upon it. Sound waves *from either direction* along an axis perpendicular to the plane of the ribbon have the maximum effect. For equal distances from the transmitter, the relative response to sound originating at various angles to the axis perpendicular to the ribbon is shown in Figure 7.

It is at once apparent that this characteristic is of considerable value in the solution of some of the

difficulties usually encountered in reverberant locations by the reduction of the effect of undesired sound reflections, and in the increased possibilities of obtaining better balance, clarity, naturalness, and selectivity in sound pickup. Extraneous direct or reflected sounds approaching the microphone from side directions will have little effect, and therefore background noises and reflected sounds in the broadcast or recording are considerably reduced, which increases, by comparison, the quality of the direct sounds reproduced. The degree of sound-proofing necessary for sound originating within the “dead zone” is, of course, dependent upon the reflecting surfaces present which may return the undesired sound to the microphone from such directions that response may be obtained.

For the same allowable reverberation pickup the operating range of the velocity microphone is approximately 1.7 times greater than a non-directional microphone having the same sensitivity.

When used for public address and sound reinforcement purposes the directional characteristic is of considerable value in reducing feed-back effects between the microphone and loudspeaker.

Sound concentrators and baffles used with condenser microphones are unnecessary with and inapplicable to the velocity microphone because of the fundamental difference in the principle of its operation. The transmitter must be used in free space where the flow of air particles is unimpeded. However, “pickup” from the rear direction of the microphone may be eliminated by placing a baffle or shield of heavy sound absorbing material, such as heavy felt, at a distance of not less than three feet from the transmitter and so confine the “pickup” to the area in front of the microphone.

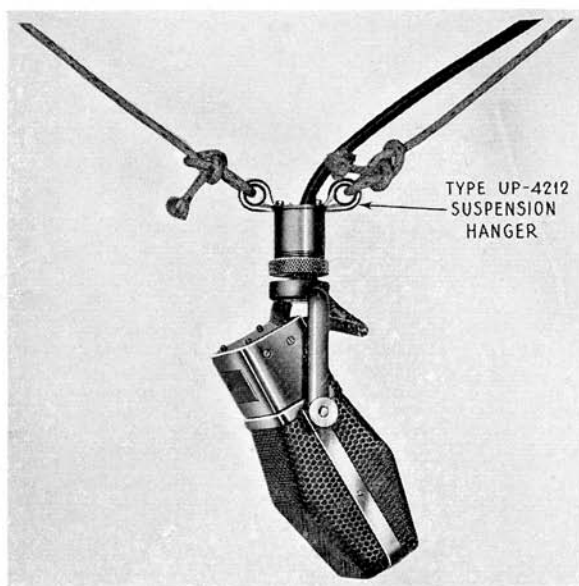

Figure 3—Microphone Suspended

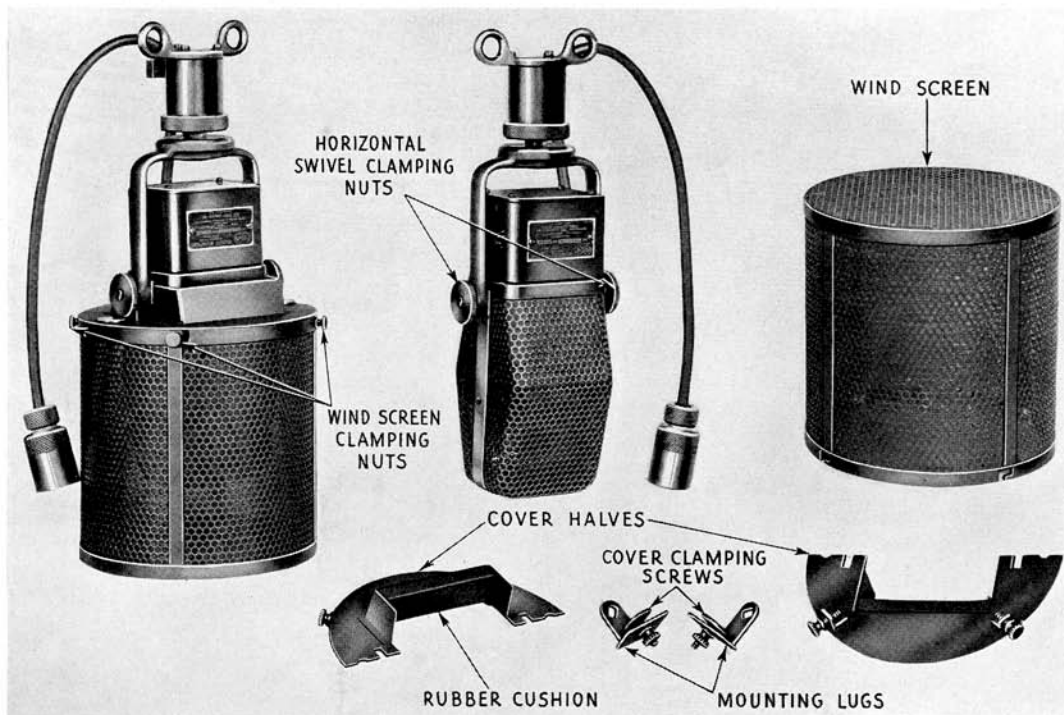

Figure 4—Microphone with Wind Screen

PART II—OPERATION

6. Microphone Assembly.—Packed in the box with the microphone unit proper is an envelope containing three (3) machine screws, three (3) lockwashers, one (1) program stand flange, and one (1) Type UP-4212 suspension hanger. The machine screws and lockwashers are used for attaching either the flange or the hanger to the microphone unit.

(a) *Stand Mounting.*—If it is desired to mount the microphone unit on a program stand, the flange, which contains a threaded socket for attaching to the program stand, must be securely fastened to the base of the microphone cushion assembly by means of the three (3) machine screws and lockwashers furnished. See Figure 2.

(b) *Suspension Mounting.*—If it is desired to suspend the microphone overhead, the suspension hanger, which contains the eyelets for cord attachment, must be securely fastened to the base of the microphone cushion assembly by means of the three (3) screws and lockwashers furnished. When attaching the hanger, see that the screw hole that is equally spaced between the eyelets is over the screw hole in the cushion assembly nearest the cable clamp. If this is done the cable will pass midway between the two eyelets to the clamp when the microphone is properly suspended. See Figure 3.

NOTE.—When the microphone is suspended see that its weight is carried by the hanger with no strain on the cable.

(c) *Assembly of Wind Screen.*—In order that the microphone may be swung on the end of a boom without the introduction of adverse wind effects a wind screen (Drawing P-600578-1) may be used. The wind screen assembled about a Type 44-A microphone is illustrated in Figure 4. The following procedure should be used when assembling the wind screen to the microphone:

(1) Remove the microphone horizontal swivel clamping nuts.

(2) Place the wind screen mounting lugs on the swivel screws with the wind screen cover clamping screws outward and downward, and replace the swivel clamping nuts.

(3) Slip the two halves of the wind screen cover under the washer heads of the cover clamping screws. The rubber cushions should be upward, and the mounting lugs entered in the notches provided for them in the cover halves.

(4) Tighten the thumb-nuts on the cover clamping screws just enough to hold the cover halves in position.

(5) Fit the screen onto the cover halves, turning the screen to bring the screen clamping screws into the horizontal portions of the slots in the rim of the screen.

(6) Tighten the screen clamping nuts and, with a screw driver, the cover clamping screws. By tightening the screen clamping screws first, the cover halves are drawn into the position most favorable to the contour of the screen. If desired,

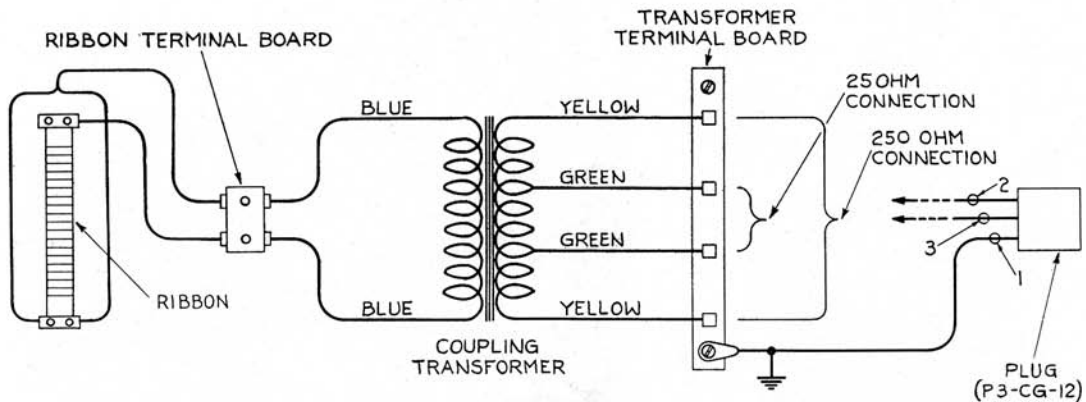

Figure 5—Schematic Wiring Diagram of Microphone and Cable

the screen cover halves may be left in position when the screen is removed.

(d) *Cable Connections.*—Remove the bottom plate from the microphone transformer housing so as to expose the transformer terminal block.

Turn the microphone at right-angles to the mounting fork and turn the fork in the base swivel so that the cable notch in the transformer housing is on the opposite side of the fork from the cable clamp.

Loosen the two screws in the cable clamp and pass the cable end through the jaws of the cable clamp, through the fork, and toward the microphone terminal block. A split, hard rubber grommet will be found between the jaws of the clamp. This grommet should be used when the cable diameter is too small for the clamping jaws to grip properly without it.

If the microphone is to feed a 250 ohm line, connect the spade terminals of the cable to the two outer terminals on the transformer terminal block. Refer to the schematic wiring diagram, Figure 5.

If the microphone is to feed a 25 ohm line, connect the spade terminals of the cable to the two inner terminals on the transformer terminal block.

Solder the ground lead from the cable shield to the lug provided under one of the terminal block mounting screws.

Lay the cable in the notch provided in the casing and replace the transformer housing bottom plate.

Turn the microphone in line with the mounting fork and rotate the microphone on its base swivel through 90 degrees. In this position the maximum required length of cable between microphone and cable clamp is reached. Allow just sufficient slack over this length to take all strain off the cable terminals, and tighten the cable clamping screws. The position of the cable with the microphone in its operating position is shown in Figure 2.

Figure 6 shows the location of the various numbered contacts of both plugs and receptacles, and, in conjunction with the schematic wiring diagram, will serve to indicate the proper connections of the various leads when testing, repairing, or replacing any electrical part.

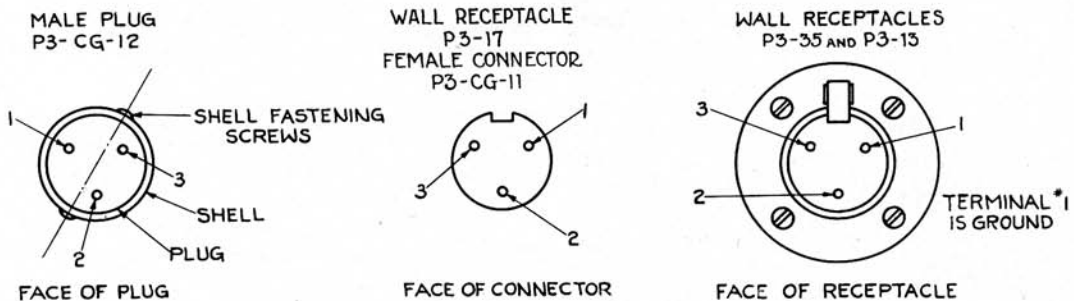

Figure 6—Plug and Receptacle Connections

ρ = LOSS IN DB BELOW RESPONSE OBTAINED ALONG
AXIS NORMAL TO PLANE OF RIBBON.

α = ANGULAR POSITION IN DEGREES OF SOURCE OF
SOUND WITH RESPECT TO AXIS NORMAL TO
PLANE OF RIBBON.

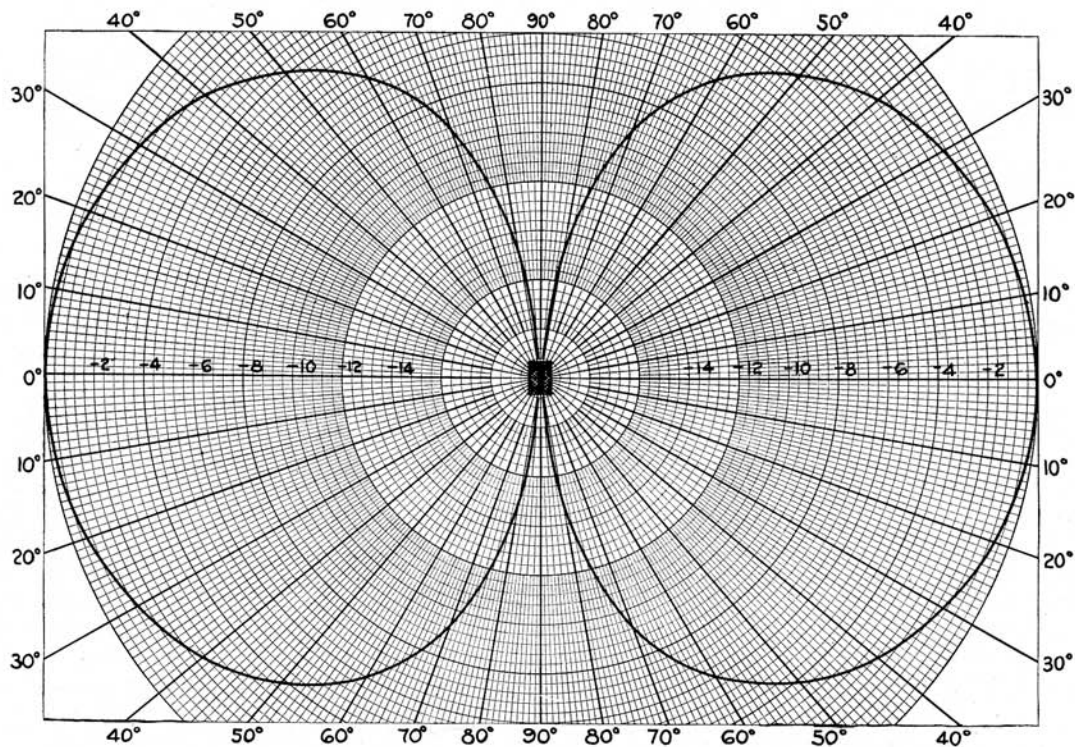

Figure 7—Directional Characteristics of Velocity Microphone

7. Technique of Velocity Microphone

Placement.—The proper placement of the microphone is essential in order to realize fully its inherent advantages. For this reason, the following instructions should be carefully studied, and close attention be given to the results of any special placement with a view towards future improvement of the technique. These instructions can of course only serve as a guide, and a study should be made to determine the best microphone placement for each condition.

(a) *General.*—The source of sound, speaker, announcer or musical instrument, should not be placed closer to the microphone than 2 feet and a distance of 3 to 4 feet is to be preferred. At shorter distances there is a tendency toward accentuation of low frequencies, which may result in making voices sound “boomy.” In this respect, the use of the velocity microphone differs greatly from that of the condenser microphone with which the speaker or soloist has usually worked at a distance of 4 to 6 inches.

The placement of a speaker or musical instrument off from the center line of the microphone

will in no way affect the quality of pickup, but will merely attenuate the direct sound pickup, thereby raising the ratio of reverberation to direct pickup.

The microphone is bi-directional. Speakers, instruments, or players may be placed on either or both sides of the microphone with equal effect. The diagrams (Figures 8, 9, 10, 11 and 12) will serve as examples of the advantages which arise from the bi-directional characteristic.

For the most satisfactory results, the microphone should not be placed closer than 3 feet to any solid reflecting surface. This statement is, of course, general and specific conditions may require otherwise, such as in footlight mounting.

The diagrams referred to in the subsequent paragraphs and the discussion concerning them can only serve to indicate some of the possible placements under particular conditions. The final decision as to what constitutes the proper placement must rest with someone who is competent to judge the quality of the results as reproduced by the monitor speaker.

(b) *Soloist with Piano.*—Interesting effects may be obtained by changing the angle of the micro-

phone with respect to the piano, thus changing the ratio of reverberation to direct pickup. The distance between the soloist and microphone should be determined by the strength of his (or her) voice, and the piano should be placed accordingly. The general arrangement is shown in Figure 8. Under no conditions should the soloist be less than 2 feet from the microphone.

(c) *Plays*.—The bi-directional characteristic of the microphone may be used to its fullest advantage in broadcasting by grouping the players about the microphone at such positions that their voice levels match to form the desired composite. See Figure 9. With such an arrangement, considerable if not all of the moving and dodging back and forth of the characters seeking positions advantageous to the presentation may be avoided.

When the microphone is used by a speaker located at a table or desk, the microphone should be so placed that it picks up direct sound from the speaker rather than reflected sound from the surface of the table, desk or manuscript.

(d) *Dance Orchestra*.—The diagram (Figure 10) is self-explanatory, the only precaution necessary being to keep the soloist at least 2 feet, and preferably 3 feet, from the microphone.

Due to the fact that artists and announcers cannot work close to the microphone, some difficulty may be experienced in obtaining the proper balance between the artist or announcer and the orchestra. This difficulty can be overcome quite satisfactorily by using two microphones, one to pick up the orchestra and the other to pick up the artist or an-

nouncer. The artist's microphone should be located so that its "dead zone" is toward the orchestra. By properly setting the mixing controls, the level of the orchestra can be controlled so that a satisfactory back-ground accompaniment of music is obtained.

In locating the microphone with respect to an orchestra, care should be taken to avoid reflected pickup from hard surfaced floors. Such reflections can be avoided by the use of carpets or similar material on the floor.

(e) *Large Orchestra*.—An arrangement for a large orchestra is shown in Figure 11. Two microphones may be used to advantage for such an assembly. See also paragraph (d) above. The arrangement shown in Figure 11 was used successfully in the RCA Victor recording studios in Camden, N. J. It must be born in mind, however, that this arrangement will not necessarily be the best in all studios because of differences in their acoustic properties. Changes in this arrangement should not need to be very extensive in order to give excellent results.

(f) *Special Considerations for Sound Motion Picture Recording*.—The directional characteristic and greater sensitivity of this microphone are especially important in sound recording for motion pictures. Because of the necessity of constructing sound stages for sight as well as sound, the acoustic properties of the set are frequently sacrificed in favor of the scenic properties, whereupon more difficulty is experienced in controlling the effect of undesired echoes and reverberations. Also, because the microphone cannot be in the field of view of

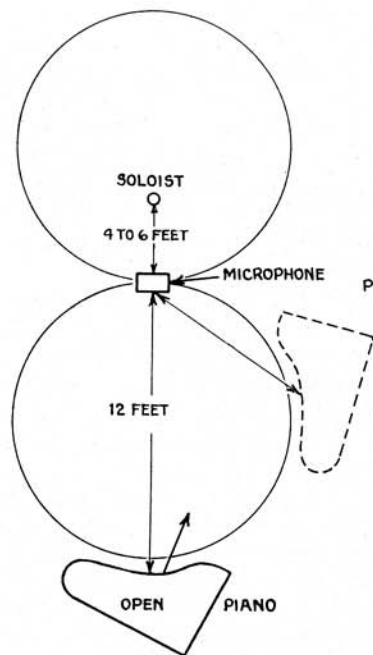

Figure 8—Soloist with Piano

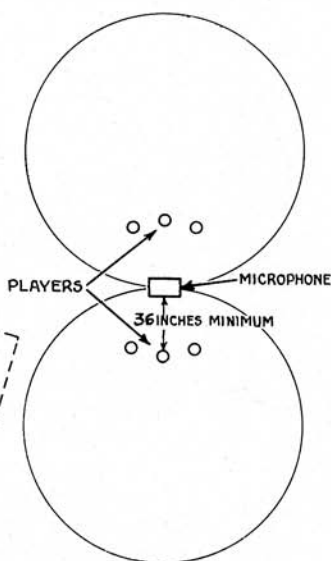

Figure 9—Plays

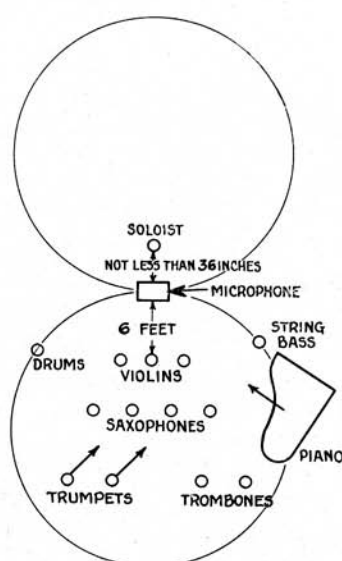
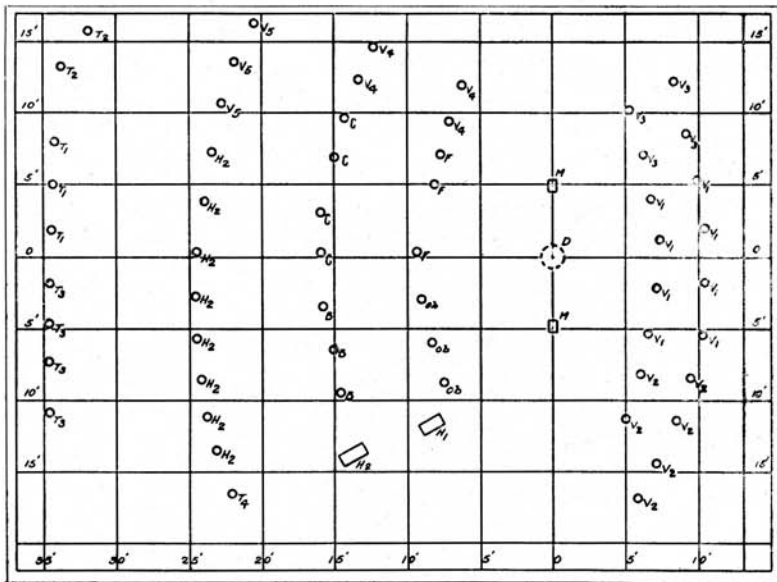

Figure 10—Dance Orchestra



- LEGEND**
- D Director
 - M 2 Velocity Microphones

 - V1 8 First Violins
 - V2 6 Second Violins
 - V3 4 Violas
 - V4 4 Cellos
 - V5 3 String Bass
 - F 3 Flutes
 - Ob 3 Oboes
 - H1 2 Harps
 - H2 8 French Horns
 - C 4 Clarinets
 - B 3 Bassoons
 - T1 3 Trumpets
 - T2 2 Tympani and Traps
 - T3 4 Trombones
 - T4 1 Tuba
 - Total—58 Musicians

Figure 11—Microphone and Orchestra Arrangement for Symphony Orchestra

the cameras, the microphone must be located farther from the actors than is the case in a broadcasting studio. With the increased distance between the sound source and the microphone, the reverberation, echo and background noise effects are more troublesome. Furthermore, there are always people and machinery in motion on the set other than those in the picture and sounds caused by them must not be picked up.

Previous to the production of the velocity microphone, it has been necessary with other microphones to use microphone baffles, sound concentrators, acoustic treatment of sets and studios, camera "blimps," etc. The use of these devices as aids to the perfect reproduction of sound and picture with the proper illusion of naturalness has not been entirely eliminated through the use of the velocity microphone, but has been greatly minimized.

As mentioned in section 5, a felt baffle may be placed so as to cut off the "pickup" of sound from directions opposite to the source of desired sound. The microphone, in many cases, may be placed so that an imaginary plane coincident with the plane of the ribbon will pass through sources of undesired sound, either direct or reflected, and so minimize the effects of extraneous or reverberant sound.

The necessity of highly sound-proofed booths and "blimps" is evidently reduced if cameras are operated in positions in the "plane of zero sound" and the degree of sound-proofing necessary for sound originating within the "dead zone" is, of course, dependent upon the reflecting surfaces present which may return the undesired sound to the microphone from such directions that response may be obtained. A camera, for example, may be

operated outside of a booth and without a "blimp" if it is placed in the plane of zero sound, providing that none of the camera noise is returned to the microphone from any other direction by reflecting surfaces, which condition may be most generally realized in out of door recording. See Figure 12.

The nearer a microphone may be placed to the subject within the limits of the foregoing paragraphs, the more natural will be the quality of

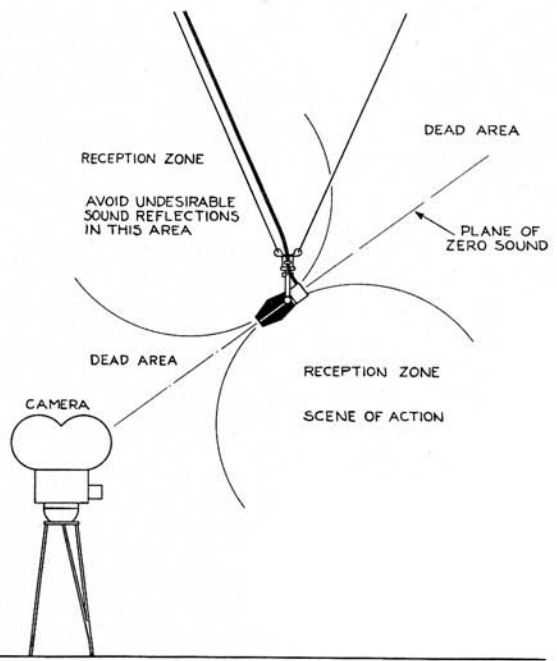

Figure 12—Camera Location for Sound Motion Picture Work

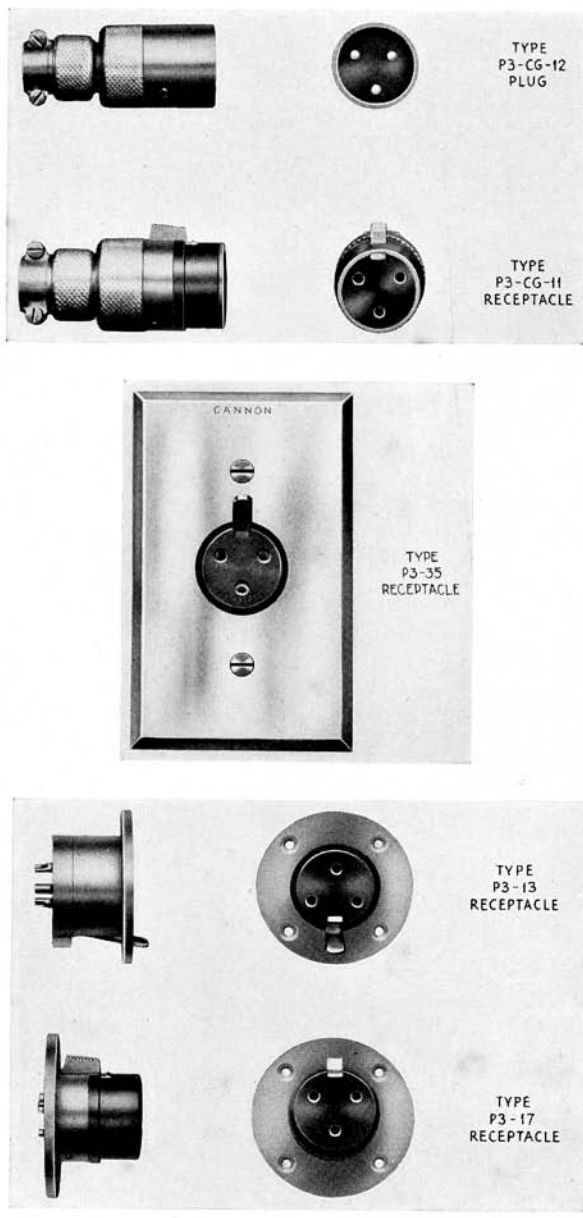

Figure 13—Plugs and Receptacles

recorded sound. This statement is made without regard to "long-shot" sound which is deliberately made poorer in order to produce the desired match between picture and sound. An indefinable quality of "presence" is the principle difference between "long-shot" and "close-up" sound and this quality is rapidly lost as the microphone is moved farther from the subject. In many cases, two cameras are trained on the subject simultaneously and at least that portion of the sound used with the close-up picture should have "presence" to match the picture. The increased field of view of the long-shot camera precludes the possibility of placing a microphone close enough to the subject to give the desired close-up sound except through the use

of the velocity microphone and by taking full advantage of its directional characteristics and increased sensitivity.

While the bi-directional characteristic of the microphone is particularly desirable for broadcasting purposes, for recording it may be desired to utilize the pickup from but one direction. Pick-up from the opposite direction may be made ineffective by placing a baffle or shield of heavy sound absorbing material, such as felt, approximately 3 feet from the microphone on the side from which the sound is to be blocked. The felt should be approximately 6 to 10 feet square.

(g) *Public Address.*—For public address use the microphone can usually be placed near the speaker (within 3 or 4 feet). It is important to see that the direction of minimum pick-up is toward the loud-speaker system to prevent acoustic feed-back. If the speaker must have latitude of movement on the stage, it may be necessary to have a microphone installed at each side to obtain satisfactory pickup.

(h) *Sound Reinforcing.*—Microphones used for this purpose must generally be concealed and may be placed and successfully operated in the wings, footlights, flies, etc. of the stage. When the microphone is placed in a footlight trough, heavy sound absorbing felt should be placed behind the microphone to prevent undesirable reflection effects. Such a system usually requires a number of microphones and the detailed location of these microphones is largely determined by the exact use of the microphone, constructional details of the stage and other conditions so numerous as to preclude any definite statement of rules or methods of application. The plane of zero sound may be utilized to great advantage in eliminating undesirable resonance, reflection and diffraction effects usually encountered when a microphone is located in a cavity. This fact accounts for the highly successful application of this microphone to footlight trough mounting. Detailed information as to the method of installation for a particular condition may be obtained on request.

8. Operation.—In general, the microphone will operate satisfactorily and require very little attention. It should give the normal output listed in section 3.

The microphone may be mounted in several ways. The most common mounting is the program or floor stand. This stand is adjustable as to height. The center of the velocity microphone may be located at any height from 56 to 81 inches above the floor. In order to raise or lower the stand, the vertical column clamping screw should first be loosened. If it is desired to raise the microphone, all that is necessary is to lift it to the desired point and there it will lock itself automatically. Usually, it will remain fixed at this position unless there is vibration or the microphone and stand are moved around. This moving may cause the stand to slowly slide downward. The clamping screw is

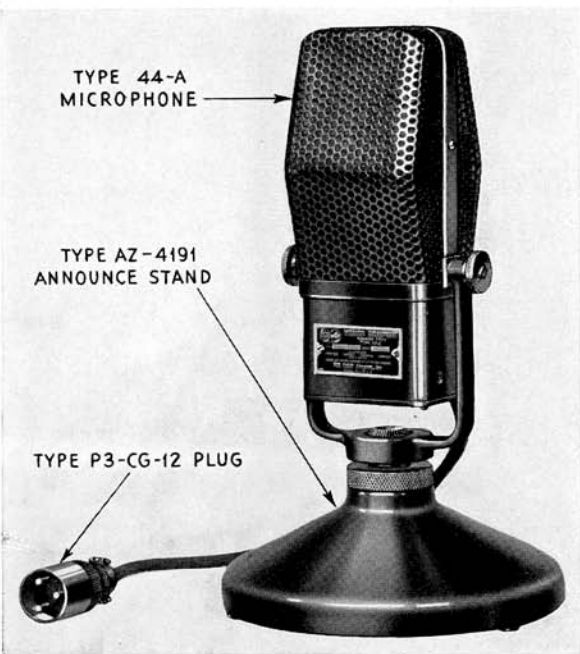

Figure 14—Microphone on Announce Stand

provided in order to prevent this. However, if the microphone does not tend to creep, then it is not necessary to use the clamping screw. When it is desired to lower the microphone stand, the clamp-

ing screw should first be loosened, then the inner tube of the microphone stand should be raised slightly while pressing the sliding column latch which projects at the side of the locking device. This will release the lock and allow the microphone to be lowered to the desired position, at which point the latch should be released and the stand will automatically lock itself. Then the clamping screw may be tightened if desired.

It is not recommended that the customer attempt to repair the microphone, but, rather that it be returned to the RCA Victor Company, Inc., for repair. This may be done by writing to the RCA Victor Company, Inc., for a "RETURNED APPARATUS" tag and "REPORT BLANK." Before doing this, however, make absolutely certain that the trouble is in the microphone and not elsewhere in the circuit.

9. List of Parts and Accessories.—

Velocity microphone (see Figure 1)	Type 44-A
Program stand (see Figure 1)	Type AZ-4090
Announce stand (see Figure 14)	Type AZ-4191
Suspension mounting (see Figure 3)	Type UP-4212
Cable and plug (see Figure 1)	Type AP-4213
Wind screen (see Figure 4)	Dwg. P-600578-1
Flush type wall receptacle (see Figure 13)	Type P3-35
Male plug to fit wall receptacle (see Figure 13)	Type P3-CG-12
Female connector to fit plug (see Figure 13)	Type P3-CG-11
Flush type wall receptacle (see Figure 13)	Type P3-13
Surface type wall receptacle (see Figure 13)	Type P3-17

MEMORANDA